

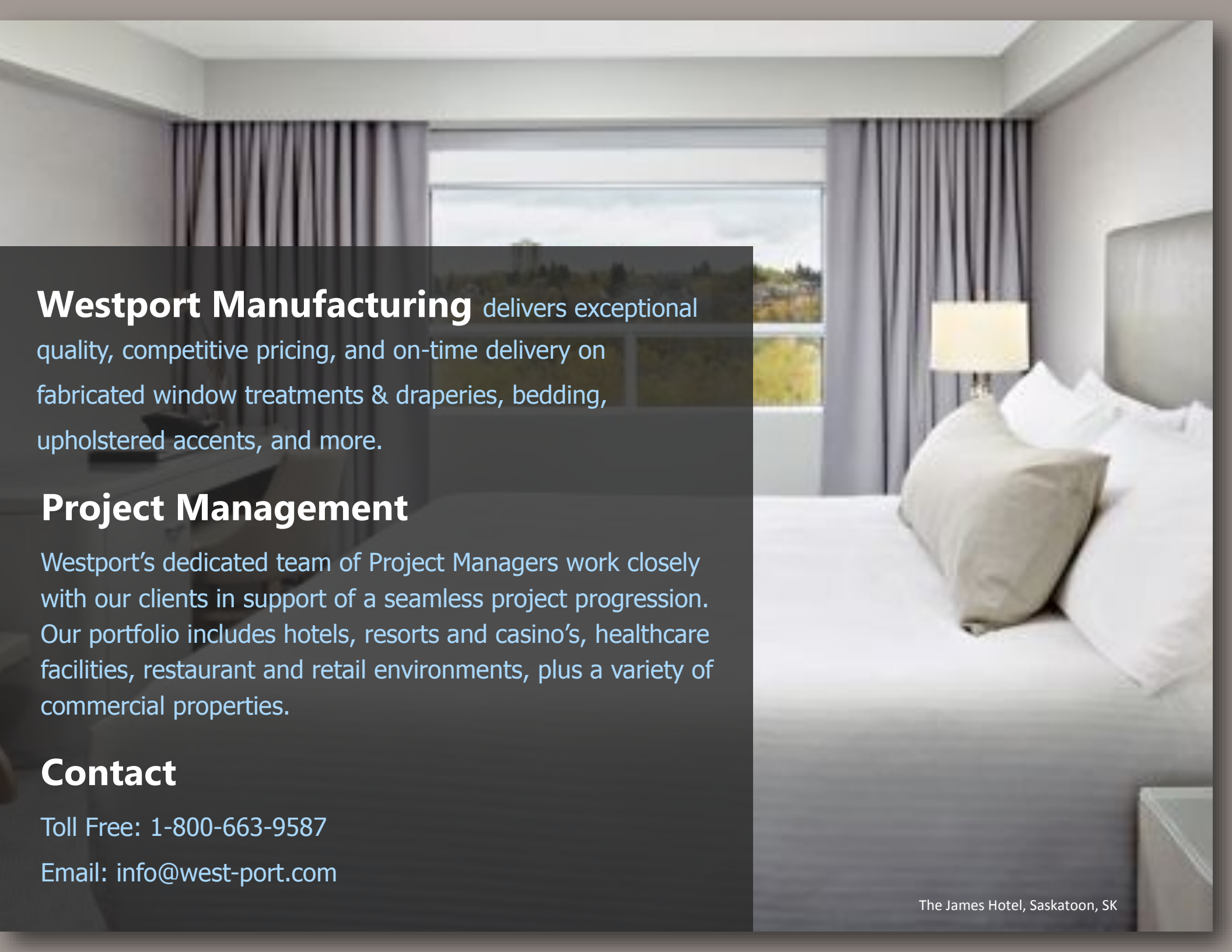

The James Hotel, Saskatoon, SK

drapery fabrication specifications

A photograph of a modern hotel room. In the foreground, a bed is neatly made with white linens and several pillows, including a large olive-green one. A bedside table with a lamp is visible. In the background, a window is framed by dark grey curtains, offering a view of a landscape with trees and a building. The room has a clean, minimalist aesthetic with neutral tones.

Westport Manufacturing delivers exceptional quality, competitive pricing, and on-time delivery on fabricated window treatments & draperies, bedding, upholstered accents, and more.

Project Management

Westport's dedicated team of Project Managers work closely with our clients in support of a seamless project progression. Our portfolio includes hotels, resorts and casino's, healthcare facilities, restaurant and retail environments, plus a variety of commercial properties.

Contact

Toll Free: 1-800-663-9587

Email: info@west-port.com

Fabrication Capabilities

Westport's experienced team of project managers and fabrication specialists, including designers, estimators, purchasing agents, and installers, ensure the highest standards for technical support, manufacturing, and customer service. With over 45,000 square feet of manufacturing space, factories on the east and west coasts, and a full complement of cutting tables and sewing equipment, we have the capacity to meet the needs of even the largest clients.

Westport Manufacturing offers a broad range of made-to-order items, including:

- Manual and motorized drapery, sheers, and Roman shades.
- Manual and motorized roller shades, wood and faux-wood blinds, and other window coverings.
- Complete top-of-bed solutions, including triple-sheeting, bedspreads, coverlets, and duvets, pillow shams, bed skirts, and bed scarves.
- Accent pillows and bolsters.
- Upholstered furniture including headboards, lounge seating, and more.

Manufacturing since 1947, Westport's decades of experience allow us to provide expertise in a wide range of fabrication applications, partnering with clients and suppliers to deliver custom-solutions to fit all project types.

Customer Service & Installation

Westport Manufacturing offers a complete range of onsite and remote installation assistance. Our service package includes:

- Dedicated project management, from project design to final installation.
- Field measurement.
- Coordinated fabric sourcing and recommendations.
- Technical design consultation.
- Installation of draperies, window coverings, and upholstered headboards.
- On-site resolution of field challenges.
- Standard product warranties, plus an additional one-year warranty on labor and workmanship.

Sheraton Cavalier, Saskatoon, SK



drapery specifications

Drapery Specifications

Standard drapery options are listed below. Our Project Managers can provide information on additional options for customization.

Styles: Pleated, Ripplefold®, and Custom Drapery
 Motorized Drapery
 Cornices and Valances

Drapery is made to the following specifications:

- Fabricated to size specifications within 0.5" lengths and 1.0" widths.
- Fabric pattern-matching according to commercial standards.
- Multiple-width drapery is serged, with partial widths placed on the return side of the drape.
- Side hems are 1.25" and double-turned. Draperies are blind stitched, using thread to complement fabric color.
- Drapery linings are joined by overlocking, and are serged at bottom with overlock machine. Linings are placed 1.25" above the bottom of the drapery.
- Draperies are available in center draw, off-centre draw, left-draw, and/or right-draw.
- It is recommended that fabrics specified for hospitality & commercial environments meet NFPA 701 fire rating requirements.

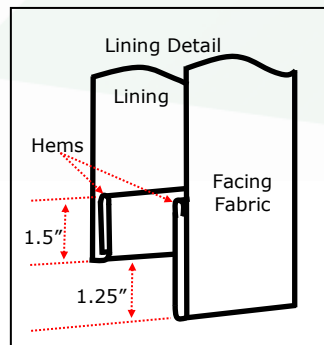
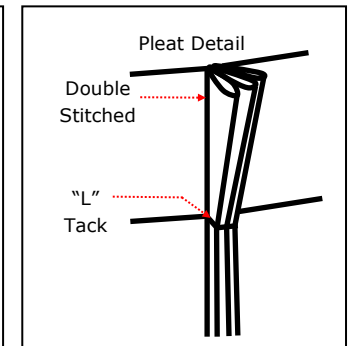
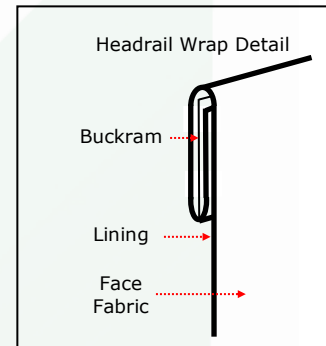
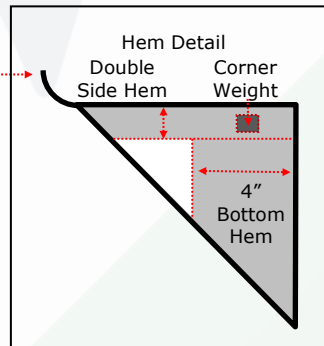
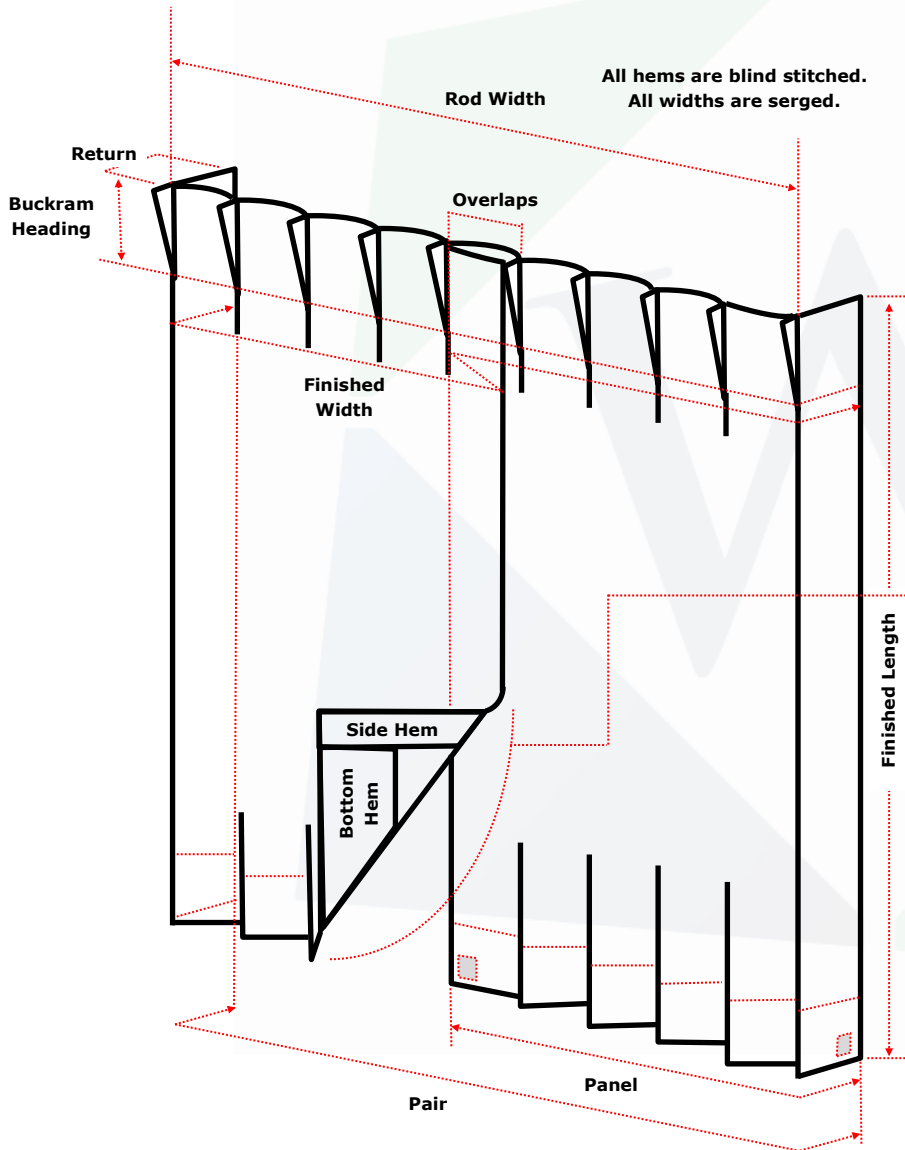

Options

Standard drapery options are listed below. Our Project Managers can provide information on additional options for customization.

Styles:	Pinch Pleat Ripplefold™
Types:	Lined Drapery Blackout Drapery Dimout Drapery Unlined Drapery Sheer Drapery
Operation:	Center Draw Off-Center Draw (One panel wider than the other) One-Way Draw (Left) One-Way Draw (Right)
Hardware:	Baton and ADA Baton (36", 48", 60" lengths) Baton is hidden behind drapery. Cord Draw - Can be specified with tension pulley to hold down cord for safety issues. Hand Draw - No baton or cord used. Motorized - Mechanism, carriers, and tracks are BTX Drapery System in white colour only.

Fullness

Pinch Pleat:	200%	Ripplefold®:	R80 (180%)
	250%		R100 (200%)
	300%		R120 (250%)
	Custom		Custom

Lining

2-Pass Blackout - White / Gray FR 54"
3-Pass Blackout - White / White FR 54"
Thermal - White
100% Polyester FR
Polycotton (65% Polyester, 35% Cotton)

Lining is recommended for all drapery. Unlined drapery is available upon request. Blackout lining is dry clean only.

Additional Options

- Shot tape, composed of continuous lead rope (can be specified for sheers, to ensure fabric hangs straight).
- Accent bands.
- Wide good options on blackout lining.



DRAPERY DIMENSIONS FORM

PLEASE COMPLETE THIS FORM IN INCHES AND RETURN, VIA EMAIL OR FAX, TO YOUR PROJECT MANAGER.

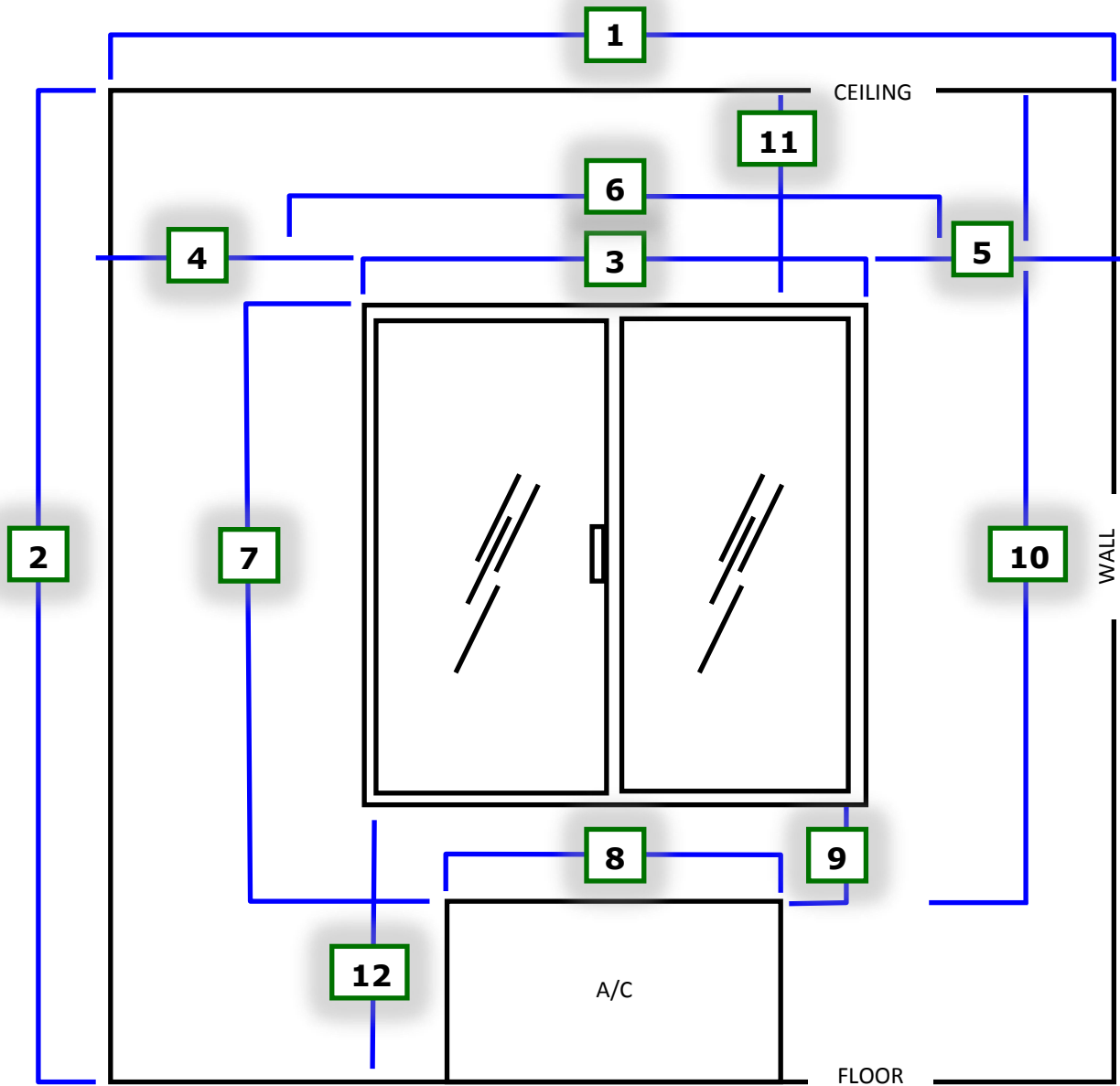

1	Wall to Wall:
2	Ceiling to Floor:
3	Window Width:
4	Width - Window to Wall (1):
5	Width - Window to Wall (2):
6	Extended Window Treatment:
7	Extended Length:
8	A/C Width:
9	Bottom of Window to A/C:
10	Ceiling to top of A/C:
11	Ceiling to top of Window
12	Bottom of Window to Floor:

Pinch Pleat Drapery

This drapery style provides the best solution for guest rooms and other areas where blackout is desired. Typically requires less labor than Ripplefold® drapery, but may require more fabric to achieve a similar visual fullness.

Fabrication Details

- Standard fabrication is 3-Finger Pinch Pleat (also known as Triple Pleat).
- Attaches to slide carriers with pin hooks.
- Headings consist of 3.5" wide buckram top stitched to face and lining, then folded over to bring lining to top of panel.
- Headings can be suspended under to track or over the face of the track.
- Features three-finger pinch pleats, spaces approx. 3" - 5" apart.
- Fullness: Typical fullness of pleats is 200 - 250%.
 - 200%
 - 250%
 - 300%
- Selvage edges are removed or clipped before fabrication, as necessary.
- Hems: 3.0" double folded at bottom.
 - Side hems: 0.25" double-turned folds.
 - Include 1/3 oz corner lead weight.
 - Blind stitched using thread to complement fabric color.
 - Blackout and lining are blind stitched.

Lining

- 2-Pass Blackout - White / Grey FR 54"
- 3-Pass Blackout - White / White FR 54"
- Thermal - White
- 100% Polyester FR
- Polycotton (65% Polyester, 35% Cotton)

Lining is recommended for all drapery, however unlined drapery is available upon request. Blackout is dryclean only - it cannot be laundered.

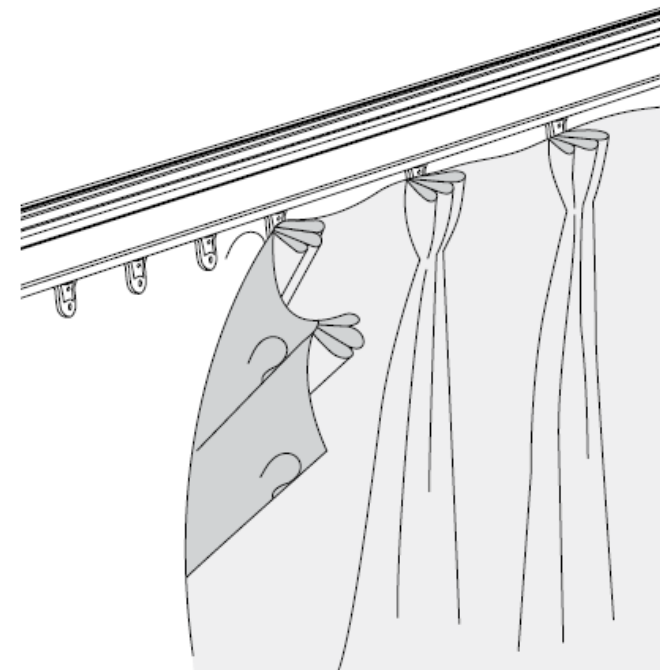

Drapery Pleat and Heading Styles

Drapery is available in a variety of pleat and heading styles. Standard fabrication is with the 3-Finger Pinch Pleat style, also known as a Triple Pleat style. For customized pleat and heading styles, as shown here, please speak with your Project Manager.

TRIPLE PLEAT
3-FINGER PINCH PLEAT

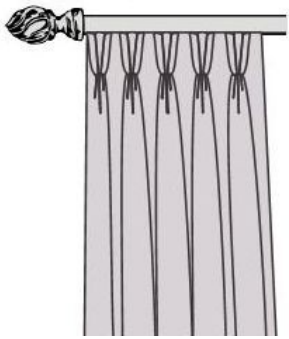

FAN PLEAT
2-FINGER PINCH PLEAT

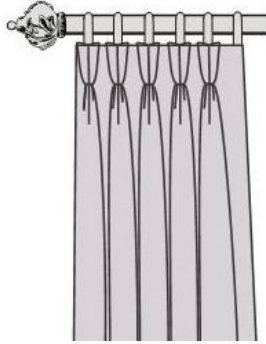

EURO PLEAT

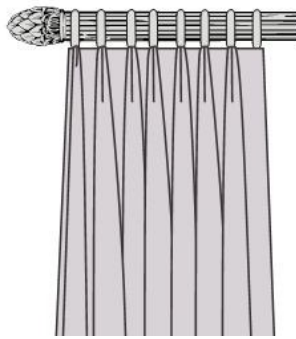

CARTRIDGE PLEAT

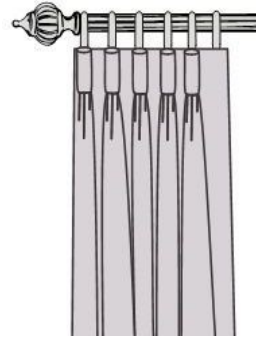

GOBLET PLEAT

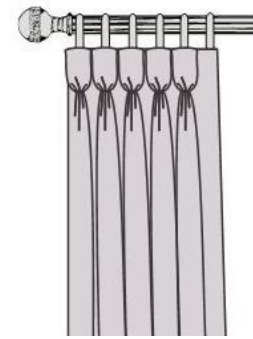

PENCIL PLEAT

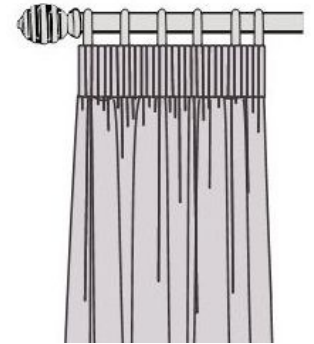

INVERTED BOX PLEAT

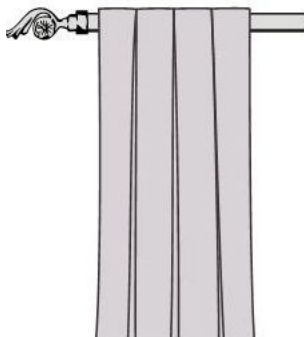

GROMMET TOP

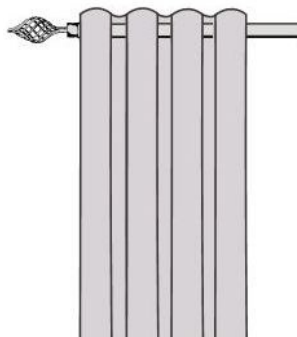

TAB TOP

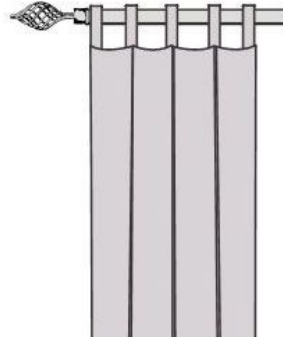

TAB TOP
WITH BUTTONS

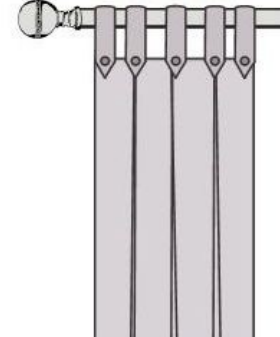

ROD POCKET

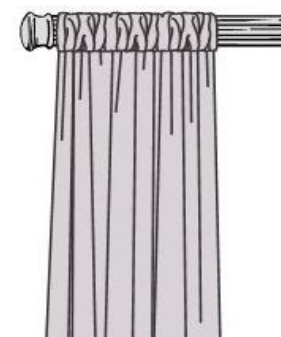

ROD POCKET
WITH RUFFLED HEADING

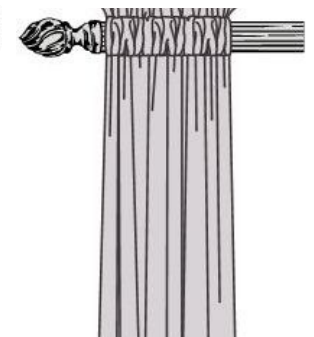

TIE TOP

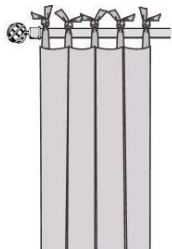

SCALLOPED TOP

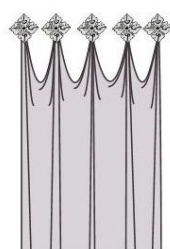

CUFF TOP

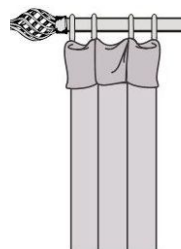

RUCHE TOP

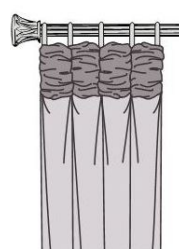

SHIRRED
TAB WITH
RUCHE TOP

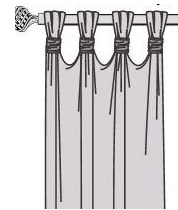

ROD POCKET
WITH ATTACHED
VALANCE



Ripplefold® Drapery

Roll-pleat (trade-name Ripplefold®) drapery fabrication attaches the panels to the track with snap tape. This offers a good solution for spaces where the drapery may need to be cleaned regularly, such as healthcare. This style produces an elegant set of smooth, regular curves from both sides. It also may use less fabric and take less stack-back space than pinch-pleat drapery. Note that Ripplefold® drapery hangs slightly below the hardware, and thus does not provide complete blackout .

Fabrication Details

- Manufactured using Ripplefold®) Nylon Snap Tape 4.25" O.C. Snaps.
- Drapery is sewn as hemmed flat panels.
- Fullness: Typically R80 Drapery / R100 Sheer
 - R80 (180%)
 - R100 (200%)
 - R120 (250%)
 - Custom
- Selvage edges are removed or clipped before fabrication, as necessary.
- Multiple widths are joined using overlapped serged seams and safety stitch.
- Hems: 3.0" double-folded at bottom.
 - Side hems: 1.0" double-turned folds
 - Include 1/3 oz corner square lead weights.
 - Blind stitched using thread to complement fabric color.
- Order drapery as rod width x finished length.

Lining

2-Pass Blackout - White / Grey FR 54"
3-Pass Blackout - White / White FR 54"
Thermal - White
100% Polyester FR
Polycotton (65% Polyester, 35% Cotton)

Blackout Lining is dryclean only - it cannot be laundered.

Snaps

- Snaps attach the drapery to the carriers.
- Snaps composed of nickel-plated brass to resist corrosion and rust.
- Snap tape is sewn into top hem of panel.
- Drapery is visible under track, meaning that hardware is visible, leaving a slight gap between track and panels.

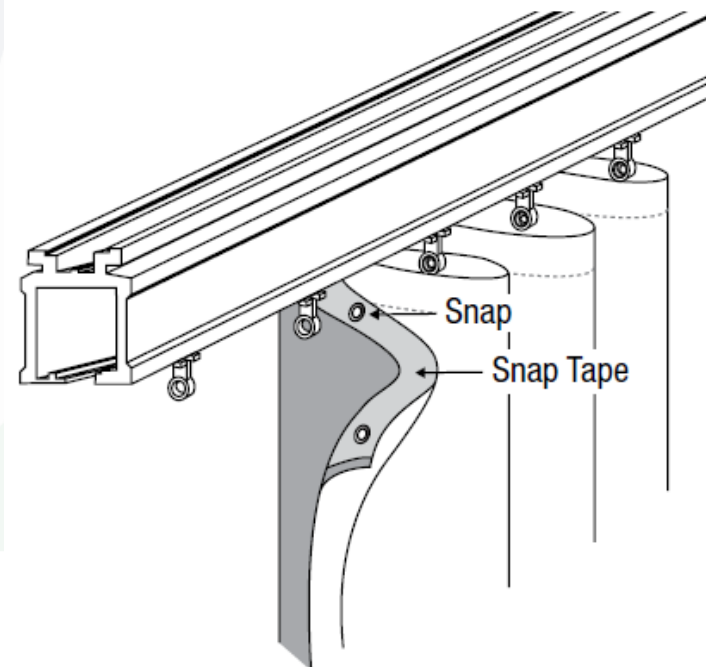

General - Pinch Pleat and Ripplefold

Hardware

- Baton and ADA Baton (36", 48", 60" lengths) - Batons are hidden behind drapery.
- Cord Draw - Can be specified with tension pulley to hold down cord for safety issues.
- Hand Draw - Excellent hardware system for use in healthcare applications; no baton or cord is used - drapery is hand-drawn.
- Motorized - Motorized mechanisms, carriers, and tracks are supplied per client specification.
- Traverse rods are on decorative hardware.

General

All work is performed to meet the following requirements.

- Drapery fabricated to size specifications within 0.5" lengths and 1.0" widths.
- Fabrics pattern-matched according to commercial standards.
- Multiple-width drapery is overlock stitched with half widths placed on the return side of the drapery.
- Side hems are blind stitched.
- Drapery linings are joined by overlocking and finished with a 2.5" hem. Linings are placed 0.75" above bottom of a drapery.
- Standard rod length is 48"; ADA rod length is 60".
- Order as "rod length" x "finished length."

Ripplefold® is a registered trademark of Kirsch.



ripplefold



pinch pleat

Valance

See diagrams and descriptions below for a selection of standard valance styles. Additional custom valance styles are on the following page.

Box Pleat

Fabrication

- Valances can be fabricated with a range of pleats along the bottom (2 - 3 is typical), in addition to the two pleats at the corner.
- Lined with 2-Pass White / Grey blackout; other options available.
- Ceiling-mounted valances use 1" x 2" wood frame.
- Wall-mounted valances fit into a designer-specified header.

Sizing

- Standard outside-mount valances will be fabricated to a width 1.0" wider (inside dimensions) than the drapery track size.
- Returns typically are 9.0" for two treatments at the window (sheer + drapery) or 11.0" for three treatments (sheer + drapery + side panels). Many variations exist; please specify.
- Common height of a valance is 14.0" to 16.0". Please specify.

Options

- Decorative banding.
- Decorative trim.
- Board or Velcro mounting.

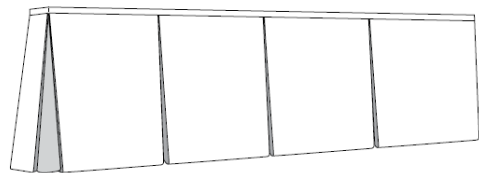

Tailored

Fabrication

- Lined with 2-Pass White / Grey blackout; other options available.
- Ceiling-mounted valances use 1" x 2" wood frame.
- Wall-mounted valances fit into a designer-specified header.

Sizing

- Standard outside-mount valances will be fabricated to a width 1.0" wider (inside dimensions) than the drapery track size.
- Returns typically are 9.0" for two treatments at the window (sheer + drapery) or 11.0" for three treatments (sheer + drapery + side panels). Many variations exist; please specify.
- Common height of a valance is 14.0" to 16.0". Please specify.

Options

- Decorative banding.
- Decorative trim,
- Velcro mounting.

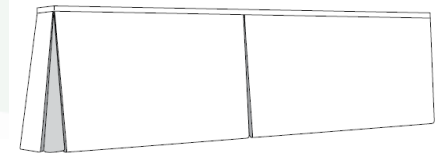

Valance

A selection of the wide variety of custom valance styles available are shown below. Please ask your Project Manager for more information.

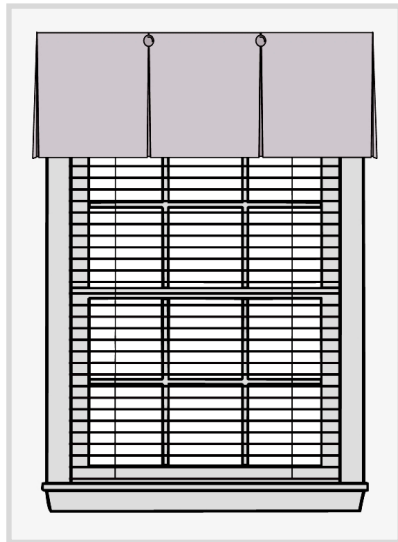

BOX PLEAT WITH BUTTON

Standard box pleat valance accented with decorative buttons. Consider a contrasting inside pleat fabric for greater visual appeal.

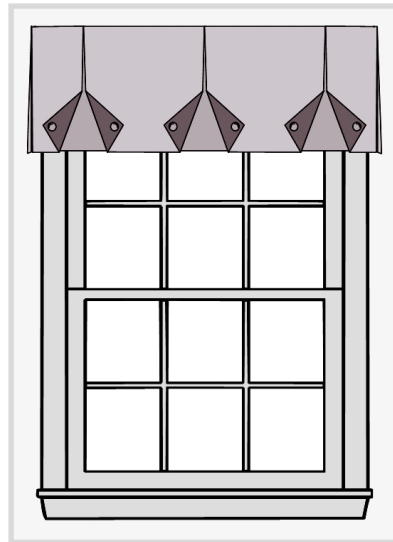

TUXEDO KICK PLEAT

A chic option in window dressing, the tuxedo kick pleat valance features multiple pleats pinned back with buttons.

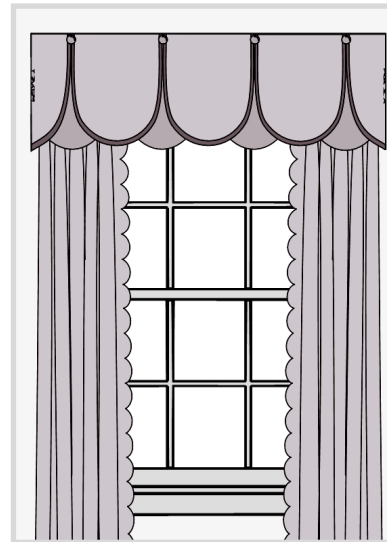

SCALLOPED

Layered petal shapes provide soft symmetry; optional with accent buttons and welting.

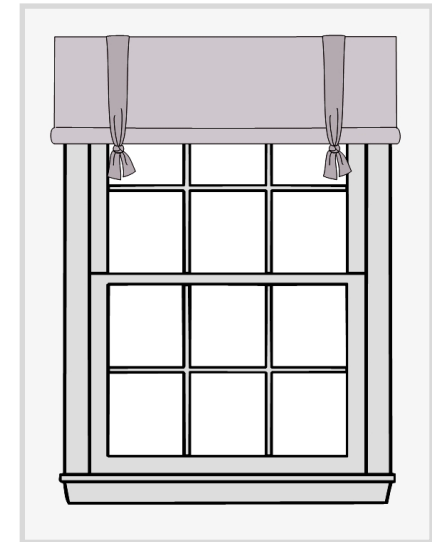

STAGECOACH

A casual valance complementing easygoing décor and featuring a rolled hem and decorative fabric ties.

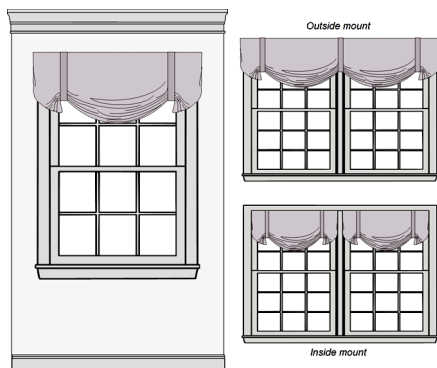

BUTTERFLY SWAG

Casual style valance with cinched bands. Can be displayed as inside or outside mount.

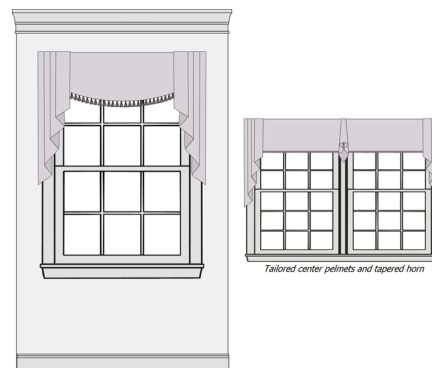

LORRAINE

Casual style valance with cinched bands. Can be displayed as inside or outside mount.

Cornices

Westport Manufacturing offers a wide range of top treatments that bring focus to the window, as well as concealing window covering hardware, to create a finished look. See diagrams for a selection of standard cornice styles. Custom fabrication is also available.

Fabrication

- Cornices have padded face standard (padding is 100% polyester fiberfill).
- Dust cap and returns composed of 0.75" plywood panel.
- Construction features self-welting on top and bottom edge of cornice.
- Styles B, C, and J are not recommended for lengths over 6.25 feet (75").
- Solid fabrics and fabrics without a directional pattern are railroaded to eliminate seams.
- Standard mounting system is aluminum angle brackets.

Sizing

- Specify the width of outside-mounted cornices,
- Returns are typically 9.0" for two treatments at the window (sheer + drapery), or 11.0" for three treatments (sheer + drapery + side panels). Many variations exist, please specify.
- Common cornice heights are 12.0" to 14.0". Other sizes are available; please specify.

Decorative Options

- Banding may be added to styles A, D, & H.
- Trim options and contrast welting are also available.

Installation

- Ceiling mount (no dust cap)
- Wall mount (with dust cap)

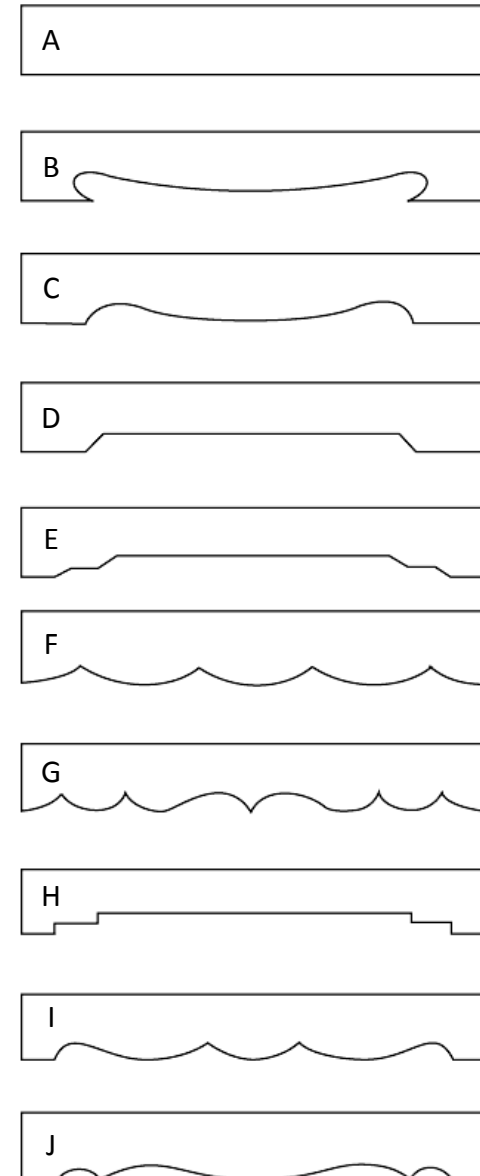

Privacy Drapery (Cubicle Curtain)

Privacy drapery and cubicle curtains are appropriate for a variety of healthcare settings, including patient rooms, long-term care and assisted living settings, urgent care locations, and doctors offices. Customers may supply COM fabric, or select from Westports' library of printed and woven FR fabrics. Stain repellency and antimicrobial finishes are available, along with a wide range of fabric options.

Size

- Width equal to length of track from which curtain is hung plus 10% added fullness, but not less than 12", added fullness.
- Length equal to floor-to-ceiling height minus 20" from finished ceiling at top, and 10" - 15" above the finished floor at bottom.

Hems

- Top: 1.5" wide, triple thickness and double lock stitched.
- Side: 0.5" wide turned and single lock stitched.
- Bottom: 1.5" wide, triple thickness and double lock stitched.

Buttonholes

- Sewn, vertical buttonholes, evenly spaced for hanging symmetry.

Grommets

- Two piece, rolled-edge, rust proof brass; spaced not more than 6" on center; machined into top hem.

Mesh Top

- 20" wide, 0.5" hole, flame-resistant nylon mesh.

Tieback

- 2" coordinating tie-back with aluminum Velcro plate.

Baton (when specified)

- 60" length x 0.375" diameter fiberglass

Cubicle Track Hardware

- Anodized aluminum with roller carriers.
- Ceiling mounted brackets included.

Fabrics

- Contact a Project Manager for information on our full selection of Cubicle Curtain fabrics.

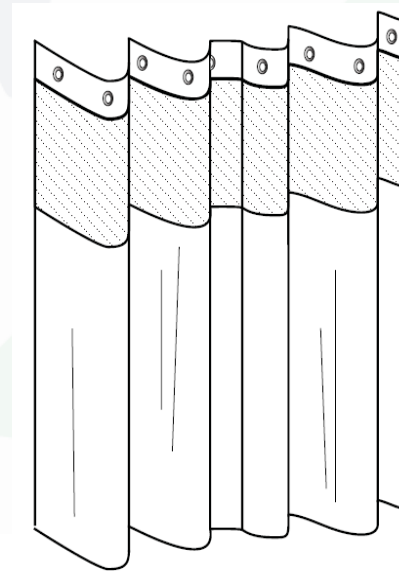

Shower Curtain

Fabrication

- Custom design variations are available, including sheer banding at top, and other options.

Size

- Shower curtains are typically fabricated at 120% of opening width.
- Standard size is 72"W x 72"H.

Buttonholes

- Sewn, vertical buttonholes, evenly spaced for hanging symmetry.

Grommets

- Attached to top hem at 6.5" on-center intervals, beginning 1.25" from edge of curtain (ie. 12 grommets per 72"W curtain).
- Standard grommets are nickel-plated brass, to resist corrosion and rust.
- Other finishes are available.

Items Not Included (please order separately)

- Liners
- Hooks
- Rods

General

All work is performed to meet the following requirements:

- Drapery fabricated to size specifications, within 0.5" lengths and 1.0" widths,
- Fabrics pattern-matched according to commercial standards.
- Multiple-width drapery is overlock stitched with half widths placed on the return side of the drapery.
- Side hems are blind stitched



Roman Shades

Manual and motorized Roman shades ensure reliability and ease of use. Shades can be made using COM (see below). Westports' fabric range also includes a wide selection of prints and wovens that can be used to fabricate Roman shades.

Styles

- **Flat Back Pleated Shades:** Constructed so the fabric gathers behind the shade as it is raised, maintaining a neat, flat appearance for the face of the shade. Cord runs through grommets for maximum durability. This shade style allows close mounting of the shade to the window when the lifting mechanism is in front of the panel. Flat shades may also be produced without pleating, using rings attached to the fabric lining to guide the cords. These are usually produced with sheer fabrics.
- **Soft Fold (Hobbled) Shades:** Face fabric is hobbled to the lining, creating curving fabric folds. This highlights the draping quality of a fabric.
- **Custom Shades:** Constructed with rings attached to the fabric. Recommended for public areas. Many other styles of gathers, pleats, and rolls are available, including:
 - Flat Back Pleated with Trim Roman Shade
 - Relaxed Roman Shade
 - Butterfly Roman Shade
 - Shaped with Decorative Banding Roman Shade
 - Fan Roman Shade
 - Balloon Roman Shade
 - Austrian Roman Shade

Fabrication

- Unlined, privacy-lined, 2-Pass blackout, and 3-Pass blackout-lined shades are available.
- For COM fabrics, customers must verify that fabric is suitable for that style of Roman shade.
 - Some shiny, stiff, or heavy fabrics will not fold correctly, and thus will not work for Roman shades.
 - Railroading fabrics may create issues with pleating / folding. It is preferable to use fabrics vertically, in the same direction they come off the roll. Pre-shrinking fabric may allow railroading of some fabrics (testing is required). When railroading is required, we recommend producing sample shades.

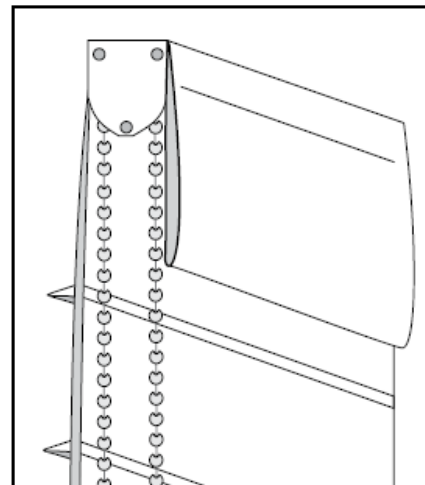

Flat Fold, shown back-mounted with valance

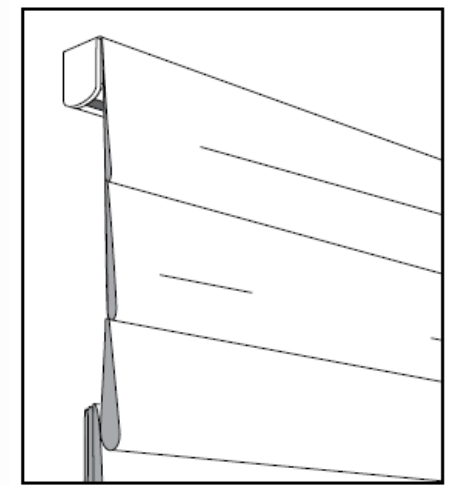

Soft Fold, shown front mounted

Note: Both Flat Fold and Soft Fold are available with either mounting option.

Roman Shade Styles

Below is a selection of Roman Shade styles. Standard Roman Shades are fabricated in the Flat Back Pleated style, which holds pleats in place when Shade is drawn. Also popular is the Soft Fold (also known as Hobbled) style, which creates soft folds when Shade is drawn.

FLAT BACK PLEATED

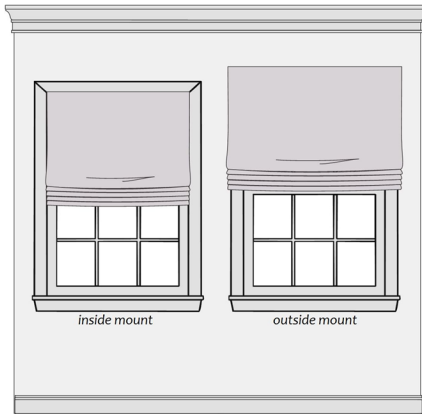

SOFT FOLD

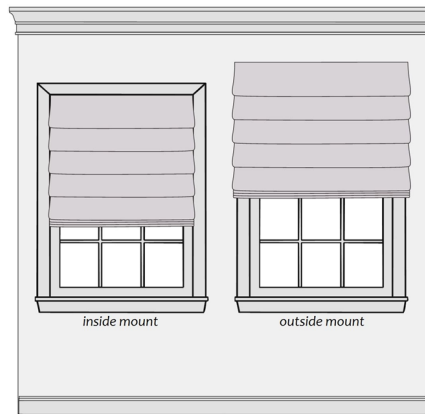

RELAXED

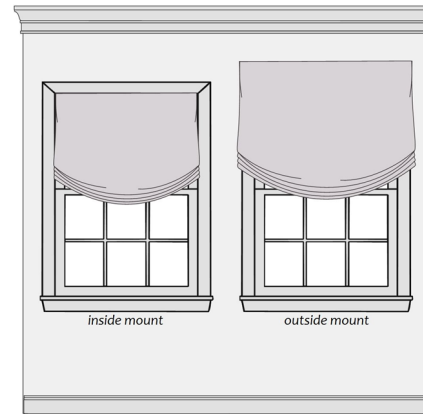

BUTTERFLY

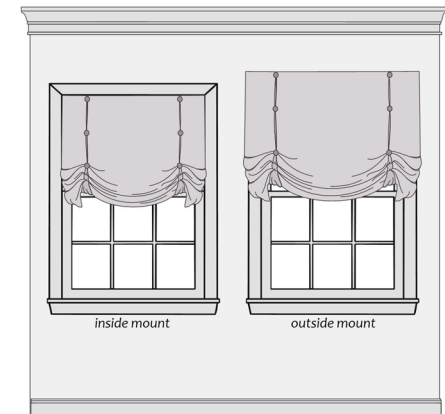

FLAT BACK PLEATED WITH TRIM

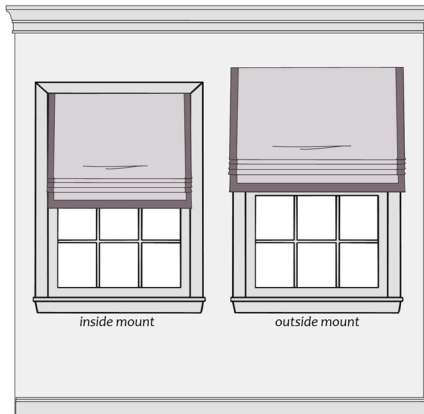

SHAPED WITH DECORATIVE BANDING

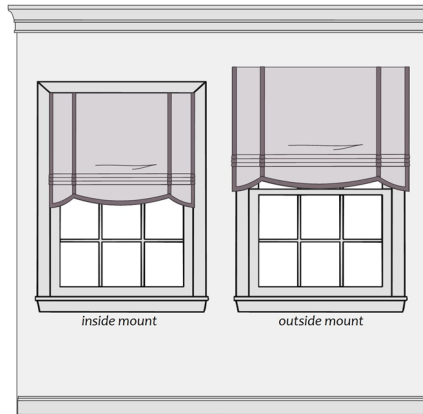

FAN

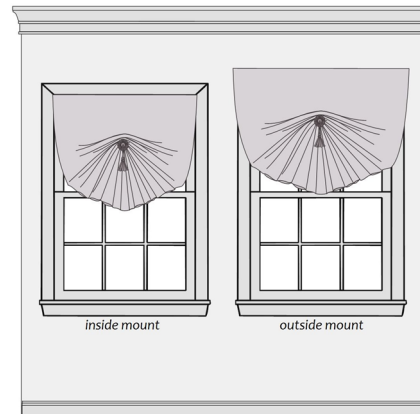

BALLOON

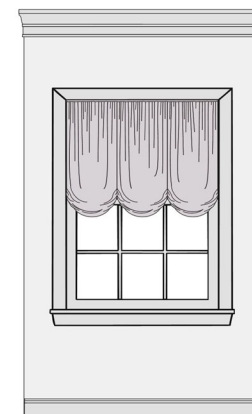

AUSTRIAN

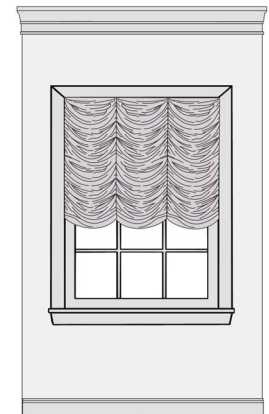

Roman Shades

Draw System

- Lifting mechanism features either extruded aluminum rail, or an industry-standard clutch system with take-up reels. Please specify mechanism type and left or right position.
- Extruded aluminum rails features a continuous lift chain that allows shade to be leveled on site without untying cords.
- Chain with stops is used when shade can be raised in one turn or less.
- Stainless steel metal beaded chain is standard; nickel-plated or plastic bead chain is also available.
- Clutch / brake system enables shade to stop and hold at any point.
- Hold-down brackets secure chain to wall in compliance with ANSI standard for child safety (ANSI WCMA A100.1, Section 6.5).
- Lifting mechanisms may be mounted in front of the panel covered by a valance for easy access to the chain. Mechanisms can also be mounted to the back panel for a cleaner look.
- Motorization - wide range of controls, including switches, remotes, and more. Virtually any width or height is possible, limited only by the characteristics of the fabric, and the ability to transport shades to the location.

Other Options

- Valance fabric that contrasts or coordinates with the shade fabric.
- Hard cornice.
- Wood valance.
- Upholstered valance.
- Decorative banding, trims, and fringes are available.
- Mounting positions: inside / outside, ceiling, and wall.

Flat Back-Pleated

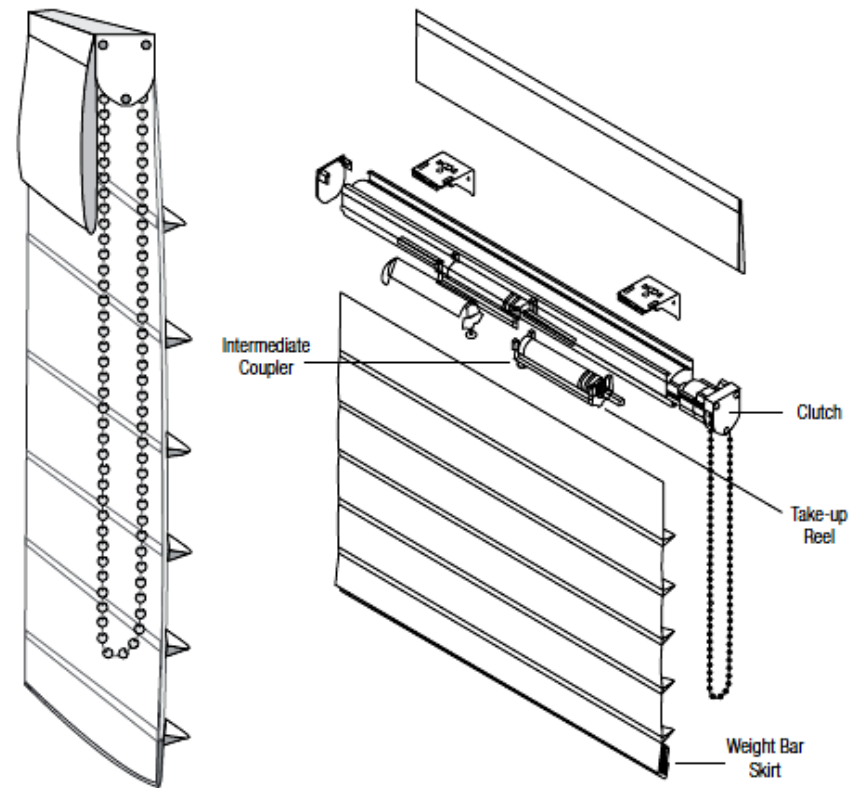

Fabric Considerations

Westports' fabric library features print and woven fabrics from a wide variety of known industry suppliers. Please contact a Project Manager at 1-800-663-9587 to discuss finding the best fabric for your project.

Printed Fabrics

- Print fabrics are created using heat transfer, and can offer exceptional savings opportunities as compared to traditional Woven options.
- Draperies and shades can be produced with most print fabric base cloths. Dyed solid fabrics can also be used as print fabric base, for added visual depth and vibrancy.

Woven Fabrics

- Woven fabrics are created using colored yarns. They are widely used for draperies and shades, and are available in a wide variety of colors and patterns, including Jacquard, Matelasse, Silk Slub, and more.





www.west-port.com
info@west-port.com

Westport Manufacturing
1122 SW Marine Drive
Vancouver, BC V6P 5Z3

Westport Manufacturing

Your complete resource for:

Draperies &
Window Coverings

Blinds, Shades,
& Motorization

Bedding, Fabrics,
& Upholstered Accents

Fabrication &
Installation
Services

We're here to help!

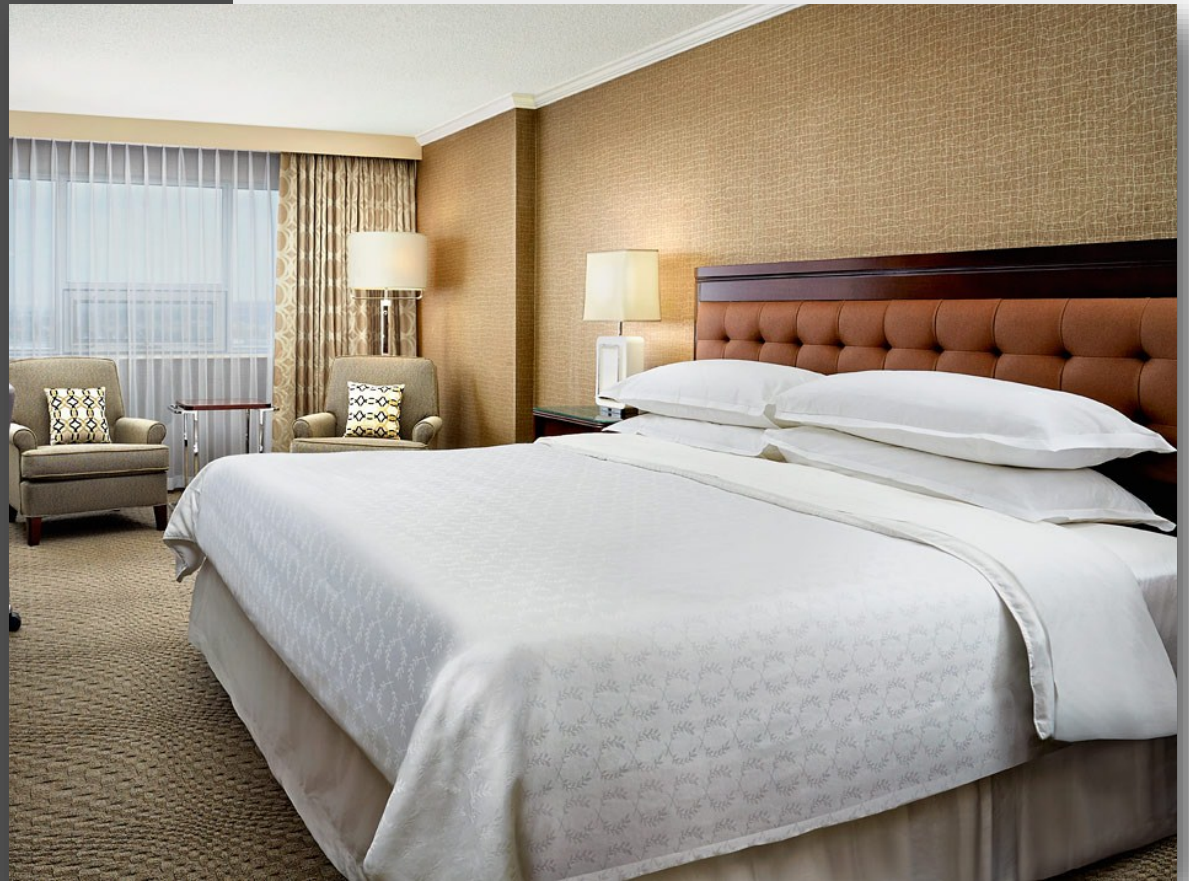

Toll Free (Western Canada): 1-800-663-9587
Toll Free (Eastern Canada): 1-888-682-9939